



CleanMount

Track Installation Instructions

STRONGARMhealthcare

Pre-Installation Information

(PLEASE READ CAREFULLY BEFORE STARTING)

Although considerable effort has been made in this manual to ensure safety, the installation itself is beyond the control of Strongarm. Accordingly, Strongarm will not be responsible for the failure of any such installation.

WARNING: It shall be the responsibility of the hospital, its consultants and/or contractors to determine that the wall is adequate to safely mount the specific instrument. This includes the selection of appropriate fasteners and proper installation.

FOR OTHER WALL BACKINGS NOT SPECIFIED IN THIS MANUAL:

Contact your structural engineer or contact Strongarm to discuss solutions.

Section 1. Tools and Parts Required

#2 Phillips screwdriver

Pan head sheet metal screw, #12 x 2-1/2" long, or 1/4" diameter toggle bolts

Hand drill, 3/16" (for sheet metal screw) or 11/16" (for toggle bolts) drill bit

(NOTE: Strongarm Healthcare does not provide any tools necessary for installation)

Section 2: Track Placement

When mounting the track, consider access to device controls and the maximum range of the arm. It is recommended to allow 14" clearance on either side of the track's center line to clear objects such as over-bed lighting, privacy curtains, and outlets.

CleanMount Placement

Typical positioning for the arm should place the user's eye-level slightly below the top of the display. Depending on whether the arm will be primarily used in a standing or sitting position, typical installation dimensions are shown here. When installing the track, be certain to allow the arm to be vertically positioned properly, while providing room for additional accessories such as bar code scanners and PC enclosures.

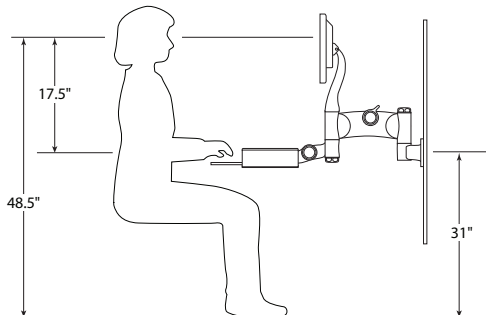
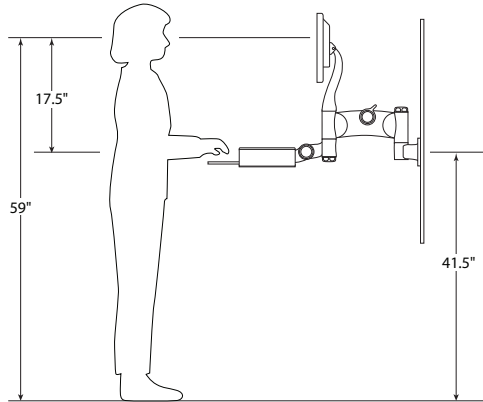

Section 3: Installation Instructions

Mounting on Drywall/Gypsum Board Over Wood Studs or 16 Gauge Steel Studs

1. Locate the building stud in the area and align the center holes of the track (*Figure A*) to the center of the wood stud.
2. Use a level to make sure the track is vertical and mark the locations on the wall through the holes centered on a stud.
3. Remove and put the track aside.
4. Drill 3/16" diameter pilot holes into the wall at the marked locations.
5. Once all holes are drilled, secure track to the wall by fastening the screws through the middle holes and into stud.

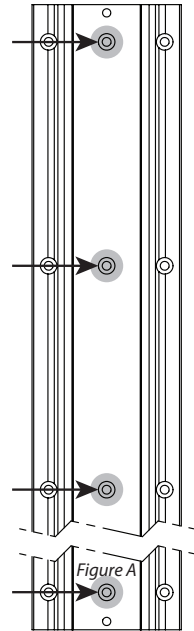
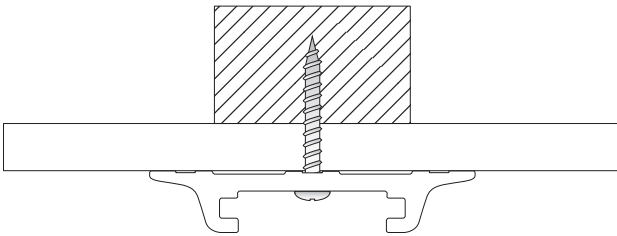

Mounting on Drywall/Gypsum Over Steel Studs Less than 16 Gauge

1. Locate the building studs in the area and align the center holes of the track (*Figure B*) to the studs.
2. Use a level to make sure the track is vertical and mark the locations on the wall through the holes centered on a stud.
3. Remove and put the track aside.
4. Drill 11/16" (1.75 cm) diameter holes into the wall at appropriate vertical spacing.
5. Once all the holes are drilled, insert the 3" long, 1/4"-20 pan head machine screws into the track and insert into the toggle wings.
6. With the track upright, align the toggle bolts to the drilled holes and insert into the studs.
7. Tighten the screws to secure the track.

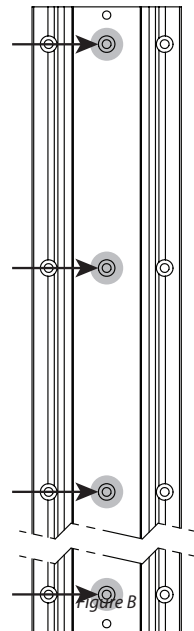
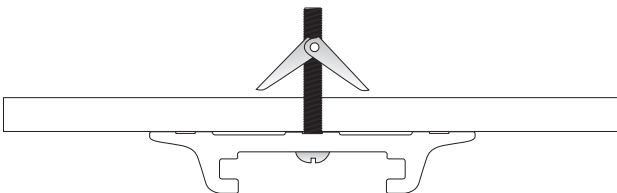

**Plaster Coat over Expanded Metal Lath on Steel Studs,
Hollow Tile, Hollow Block:**

1. Drill 11/16" (1.75 cm) holes in track center holes (Figure C).
2. Insert screws through Wall Channel holes then affix the toggle wings to the screws.
3. Insert toggle wings into previously drilled holes.
4. Use a level to make sure the channel is vertical prior to final seating of the screws.

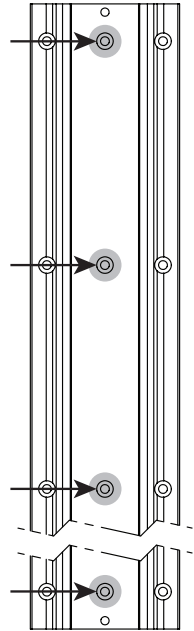
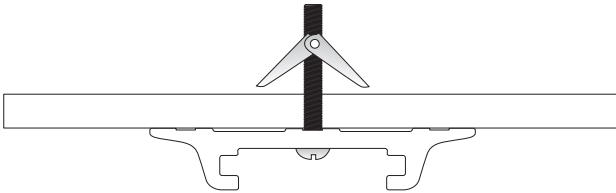

Figure C

Concrete Walls:

Refer to Structural Engineer.

Section 4: CleanMount Installation

Refer to the CleanMount Quick Installation Guide for CleanMount installation instructions, or visit www.strongarmhealthcare.com for instructional videos.

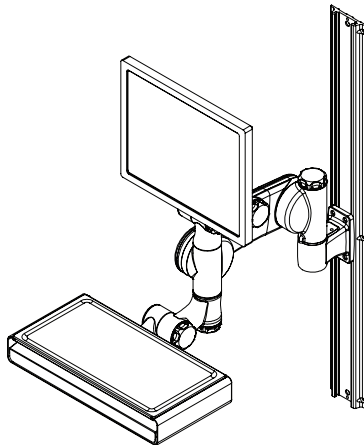

Strongarm Healthcare
215.443.3400
425 Caredean Drive
Horsham PA 19044
www.strongarmhealthcare.com
© 2017, Strongarm Designs, Inc.

Document #CMRINS0717REV0